

## LM3590 Series White LED Driver

Check for Samples: [LM3590](#)

### FEATURES

- Drives up to 3 stacked white LEDs
- 6.0V-12.6V input voltage range
- Up to 20mA LED output current
- Excellent LED current matching guaranteed by series configuration
- Single connection to the White LEDs in the display module
- Tightly controlled programmable current source
- Low shutdown current (0.1µA typ.)

- PWM brightness control
- Very small solution size
- SOT23-5 package: 3mm × 3mm × 1.0mm (L×W×H)

### APPLICATIONS

- White LED Display Backlights
- Keypad Backlights
- General purpose constant current driver for high forward-voltage LEDs

### DESCRIPTION

The LM3590 is a White LED constant current driver capable of supplying up to 3 White LEDs connected in series with 20mA. This device operates over a wide 6V-12.6V input voltage range. The output can accommodate LEDs with a combined forward voltage of up to 11.5V, from a 12V input supply. The LED drive current is programmed by using an external resistor on the I<sub>SET</sub> pin.

LED brightness can be linearly varied up to the programmed LED current by applying a Pulse Width Modulated (PWM) signal to the EN pin of the device. The LED output current of the LM3590 is tightly controlled over temperature and voltage. LED Current matching is guaranteed due to the series configuration of the LEDs. The series topology also simplifies the connection between the White LEDs in the display module and the LM3590 since only one connection is required.

The LM3590 typically draws only 50µA when operating in the no-load condition and draws less than 0.1µA when the device is shut down.

The LM3590 is available in a small 5-pin SOT23 package.

### Typical Application Circuit

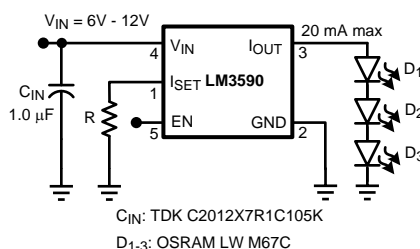
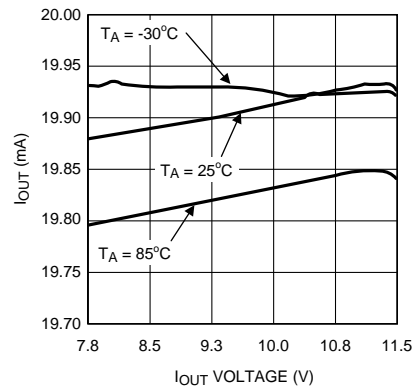

Figure 1. Typical Application Circuit



Please be aware that an important notice concerning availability, standard warranty, and use in critical applications of Texas Instruments semiconductor products and disclaimers thereto appears at the end of this data sheet.

All trademarks are the property of their respective owners.



**Figure 2. I<sub>OUT</sub> vs V<sub>OUT</sub>**

## Connection Diagram

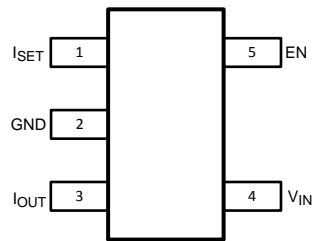

**Figure 3. Top View**

## Pin Functions

### Pin Descriptions

Pin #	Name	Function
1	I <sub>SET</sub>	Programmable LED current Input. The LED current has the following relationship with the resistor used: $R_{SET} = 100 \times (125 \div I_{OUT}) \quad (1)$
2	GND	Ground Connection
3	I <sub>OUT</sub>	Constant Current LED Output
4	V <sub>IN</sub>	Power Supply Voltage Input. Input voltage range: 6V-12.6V
5	EN	Device Enable



These devices have limited built-in ESD protection. The leads should be shorted together or the device placed in conductive foam during storage or handling to prevent electrostatic damage to the MOS gates.

### Absolute Maximum Ratings <sup>(1)</sup> <sup>(2)</sup>

$V_{IN}$	-0.3 to 13.0V Max
EN	-0.3 to ( $V_{IN}+0.3V$ ) w/ 13.0V max
Maximum Junction Temperature, $T_{JMAX}$	150°C
Storage Temperature	-65°C to +150°C
Maximum Lead Temperature (Soldering, 5 sec.)	260°C
ESD Rating <sup>(3)</sup>	
Human Body Model	1.5kV
Machine Model	200V

- (1) Absolute Maximum Ratings indicate limits beyond which damage to the device may occur. Operating Ratings are conditions under which operation of the device is guaranteed. Operating Ratings do not imply guaranteed performance limits. For guaranteed performance limits and associated test conditions, see the Electrical Characteristics table.
- (2) All voltages are with respect to the potential at the GND pin.
- (3) The human-body model is a 100pF capacitor discharged through a 1.5kΩ resistor into each pin. The machine model is a 220pF capacitor discharged directly into each pin.

### Operating Conditions

Input Voltage Range	6.0V to 12.6V
EN Voltage Range	0V to $V_{IN}$
Ambient Temperature ( $T_A$ ) Range <sup>(1)</sup>	-40°C to +85°C
Junction Temperature ( $T_J$ ) Range	-40°C to +110°C

- (1) Maximum ambient temperature ( $T_{A-MAX}$ ) is dependent on the maximum operating junction temperature ( $T_{J-MAX-OP} = 110^\circ\text{C}$ ), the maximum power dissipation of the device in the application ( $P_{D-MAX}$ ), and the junction-to-ambient thermal resistance of the part/package in the application ( $\theta_{JA}$ ), as given by the following equation:  $T_{A-MAX} = T_{J-MAX-OP} - (\theta_{JA} \times P_{D-MAX})$ . The ambient temperature operating rating is provided merely for convenience. This part may be operated outside the listed  $T_A$  rating, so long as the junction temperature of the device does not exceed the maximum operating rating of 110°C.

### Thermal Information

Junction-to-Ambient Thermal Resistance, SOT23-5 Package ( $\theta_{JA}$ ) <sup>(1)</sup>	220°C/W
--	---------

- (1) Junction-to-ambient thermal resistance is highly application and board-layout dependent. In applications where high maximum power dissipation exists, special care must be paid to thermal dissipation issues. For more information on these topics, please refer to the **Power Dissipation** section of this datasheet.

## Electrical Characteristics (1) (2)

Limits in standard typeface are for  $T_J = 25^\circ\text{C}$  and limits in **boldface** type apply over the full Operating Junction Temperature Range ( $-40^\circ\text{C} \leq T_J \leq +110^\circ\text{C}$ ). Unless otherwise specified,  $C_{IN} = 1 \mu\text{F}$ ,  $V_{IN} = 12.0\text{V}$ ,  $V_{EN} = 3.0\text{V}$ ,  $R_{SET} = 6.19\text{k}\Omega$ ,  $V_{IOUT} = 10.8\text{V}$ .

Symbol	Parameter	Conditions	Min	Typ	Max	Units
$I_{OUT}$	Output Current Capability	$V_{IN} = 12\text{V}$ $7.5\text{V} \leq V_{IOUT} \leq 11.5\text{V}$	<b>19</b> (-5%)	20	<b>21</b> (+5%)	mA
		$V_{IOUT} = 10.8\text{V}$ $11.3\text{V} \leq V_{IN} \leq 12.6\text{V}$	<b>19</b> (-5%)	20	<b>21</b> (+5%)	
		$R_{SET} = 8.35\text{k}\Omega$		15		
	Output Current Programming	$R_{SET} = 12.5\text{k}\Omega$		10		A
	$I_{OUT}$ ratio to $I_{SET}$			100:1		
$I_Q$	Quiescent Supply Current	$11.3\text{V} \leq V_{IN} \leq 12.6\text{V}$ $R_{SET} = \text{OPEN}$ $I_{OUT} = \text{OPEN}$		50	<b>75</b>	$\mu\text{A}$
$I_{SD}$	Shutdown Supply Current	$V_{IN} = 12.6\text{V}$ $V_{EN} = 0\text{V}$		0.1	<b>1</b>	$\mu\text{A}$
$V_{ISET}$	$I_{SET}$ Reference Voltage			1.25		V
$V_{HR}$	Minimum Current Source Voltage Headroom ( $V_{IN} - V_{IOUT}$ ) <sup>(3)</sup>	$I_{OUT} = 95\%$ nominal		300		mV
$V_{IH}$	Logic Input EN: High level		<b>1.1</b>		$V_{IN}$	V
$V_{IL}$	Logic Input EN: Low level		<b>0</b>		<b>0.3</b>	V
$I_{EN}$	Enable Pin Input Current <sup>(4)</sup>			6		$\mu\text{A}$
$t_{ON}$	Turn-On Time	$I_{OUT} = 90\%$ of steady state		50		$\mu\text{s}$

- (1) All voltages are with respect to the potential at the GND pin.
- (2) All room temperature limits are 100% tested or guaranteed through statistical analysis. All limits at temperature extremes are guaranteed by correlation using standard Statistical Quality Control methods (SQC). All limits are used to calculate Average Outgoing Quality Level (AOQL). Typical numbers are not guaranteed, but do represent the most likely norm.
- (3) The current source is connected internally between  $V_{IN}$  and  $V_{IOUT}$ . The voltage across the current source,  $[V_{IN} - V_{IOUT}]$ , is referred to as headroom voltage. For the current source to regulate properly, a minimum headroom voltage must be present across it. Minimum required headroom voltage is proportional to the current flowing through the current source, as dictated by this equation:  $V_{HR-MIN} = 300\text{mV} \times (I_{OUT} \div 20\text{mA})$ .
- (4) An internal  $500\text{k}\Omega$  pull-down resistor is connected between the EN and GND pins.

## Functional Block Diagram

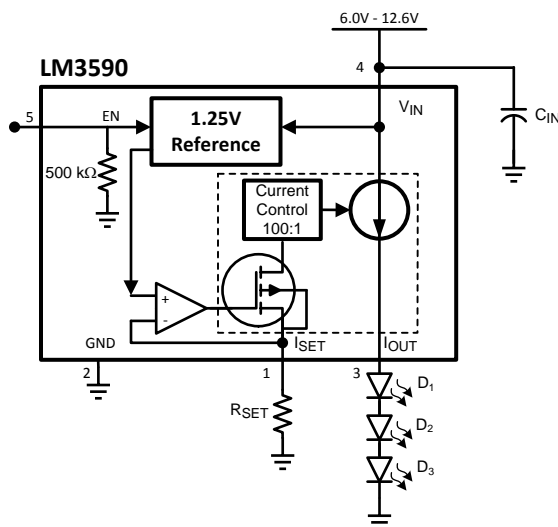

### Typical Performance Characteristics

Unless otherwise specified,  $C_{IN} = 1\mu\text{F}$ ,  $V_{IN} = 12.0\text{V}$ ,  $V_{EN} = 3.0\text{V}$ ,  $V_{IOUT} = 10.8\text{V}$ ,  $R_{SET} = 6.19\text{k}\Omega$ ,  $T_A = 25^\circ\text{C}$ .  $C_{IN}$  is a low ESR multi-layer ceramic capacitor (MLCC).

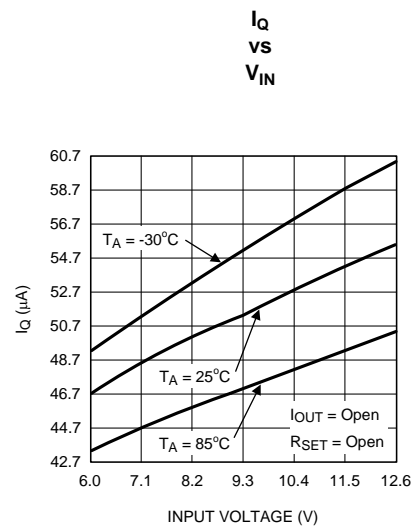
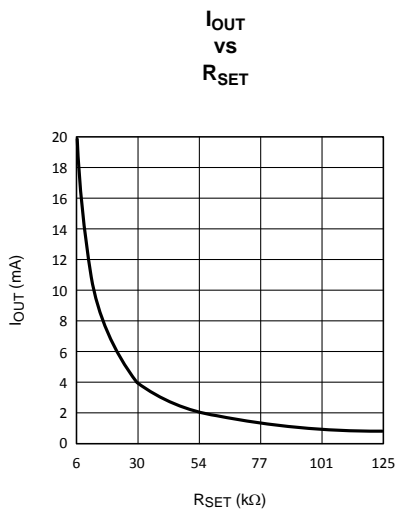
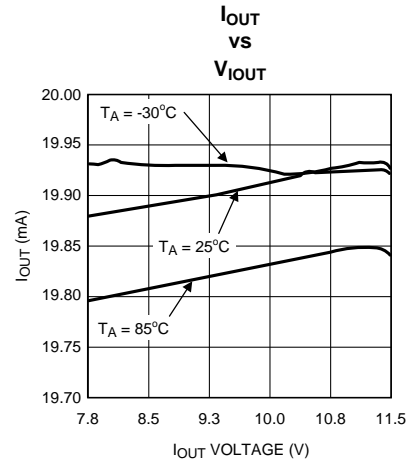
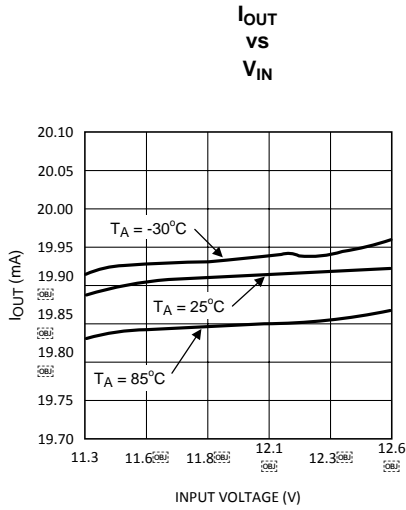

### Typical Performance Characteristics (continued)

Unless otherwise specified,  $C_{IN} = 1\mu\text{F}$ ,  $V_{IN} = 12.0\text{V}$ ,  $V_{EN} = 3.0\text{V}$ ,  $V_{IOUT} = 10.8\text{V}$ ,  $R_{SET} = 6.19\text{k}\Omega$ ,  $T_A = 25^\circ\text{C}$ .  $C_{IN}$  is a low ESR multi-layer ceramic capacitor (MLCC).

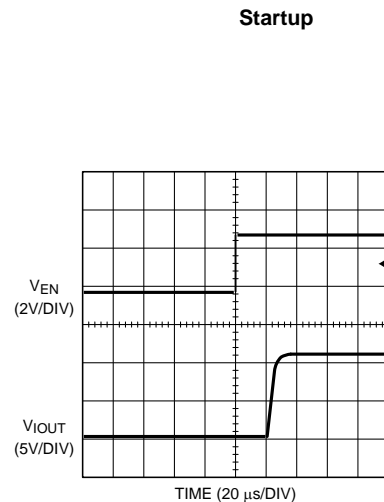
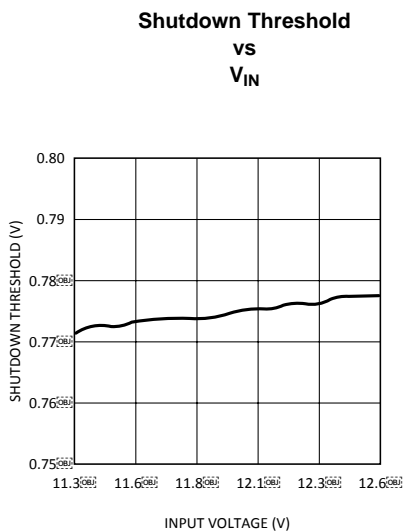
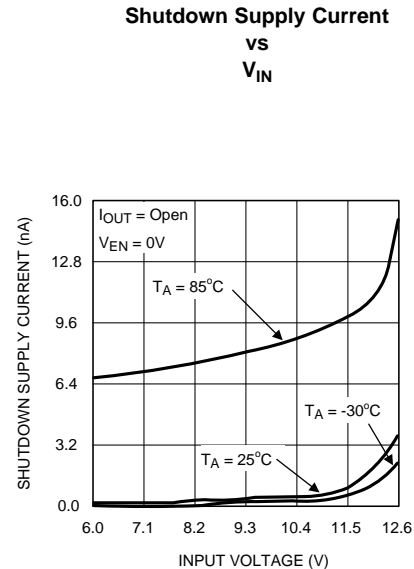
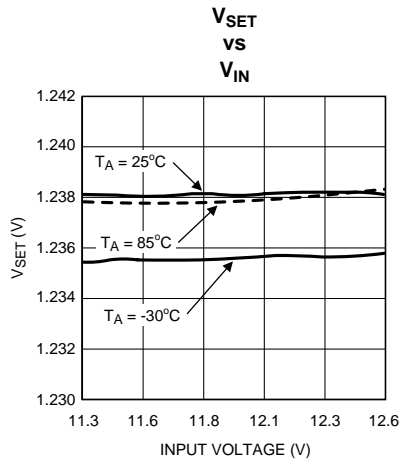

## Application Information

### CIRCUIT DESCRIPTION

The LM3590 is a constant current series White-LED Driver, providing up to 20mA from an input voltage between 7.5V to 12.6V. To set the LED drive current, the LM3590 uses a resistor connected to the  $I_{SET}$  pin to set a reference current. This reference current is then multiplied and mirrored to the constant current output,  $I_{OUT}$ . The LED brightness can be controlled by applying a PWM (Pulse Width Modulation) signal to the Enable pin (EN). (see **PWM BRIGHTNESS CONTROL PROCEDURES** section).

## ENABLE MODE

The Enable pin (EN) disables the part and reduces the quiescent current to 0.1µA (typ.). The LM3590 has an active-high enable pin (LOW = shut down, HIGH = operating). The LM3590 EN pin can be driven with a low-voltage CMOS logic signal (1.5V logic, 1.8V logic, etc). There is an internal 500kΩ pull-down between the EN and GND pins of the LM3590.

## CAPACITOR SELECTION

Although not required for normal operation, a capacitor can be added to the voltage input of the LM3590 to reduce line noise. A surface-mount multi-layer ceramic capacitor (MLCC) is recommended. MLCCs are small, inexpensive and have very low equivalent series resistance (ESR,  $\leq 15\text{m}\Omega$  typ.). MLCCs with a X5R or X7R temperature characteristic are preferred for use with the LM3590. Table 1 lists suggested capacitor suppliers for the typical application circuit.

**Table 1. Ceramic Capacitor Manufacturers**

Manufacturer	Contact
TDK	<a href="http://www.component.tdk.com">www.component.tdk.com</a>
Murata	<a href="http://www.murata.com">www.murata.com</a>
Taiyo Yuden	<a href="http://www.t-yuden.com">www.t-yuden.com</a>

## LED SELECTION

The LM3590 is designed to drive up to 3 LEDs with the combined forward voltages of the LEDs being no greater than 11.5V, when using a 12V input supply. The typical and maximum diode forward voltage depends highly on the manufacturer and their technology. Table 2 lists two suggested manufacturers. LED Forward current matching is guaranteed by design, due to the series LED configuration of the LM3590.

**Table 2. White LED Selection**

Manufacturer	Contact
Osram	<a href="http://www.osram-os.com">www.osram-os.com</a>
Nichia	<a href="http://www.nichia.com">www.nichia.com</a>

## LED HEADROOM VOLTAGE ( $V_{HR}$ )

A single current source is connected internally between  $V_{IN}$  and  $I_{OUT}$ . The voltage across the current source, ( $V_{IN} - V_{I_{OUT}}$ ), is referred to as headroom voltage ( $V_{HR}$ ). The current source requires a sufficient amount of headroom voltage to be present across it in order to regulate properly. Minimum required headroom voltage is proportional to the current flowing through the current source, as dictated by the equation:

$$V_{HR-MIN} = k_{HR} \times I_{OUT} \quad (2)$$

The parameter  $k_{HR}$ , typically 15mV/mA in the LM3590, is a proportionality constant that represents the ON-resistance of the internal current mirror transistors. For worst-case design calculations, using a  $k_{HR}$  of 20mV/mA is recommended. (Worst-case recommendation accounts for parameter shifts from part-to-part variation and applies over the full operating temperature range). Figure 4 shows how output current of the LM3590 varies with respect to headroom voltage.

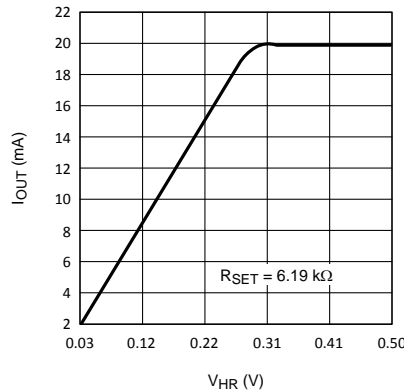

**Figure 4. I<sub>OUT</sub> vs V<sub>HR</sub>**  
 $V_{HR} = V_{IN} - V_{IOUT}$   
 $V_{IN} = 12.0V$

On the flat part of the graph, the current is regulated properly as there is sufficient headroom voltage for regulation. On the sloping part of the graph the headroom voltage is too small, the current source is squeezed, and the current drive capability is limited. Thus, operating the LM3590 with insufficient headroom voltage across the current source should be avoided.

### I<sub>SET</sub> PIN

An external resistor, R<sub>SET</sub>, connected to the I<sub>SET</sub> pin sets the output current. The internal current mirror sets the series LED output current with a 100:1 ratio to the current through R<sub>SET</sub>. The current matching through each LED is guaranteed by the series LED drive topology. The following equation approximates the LED current:

$$I_{OUT} = 100 \times (1.25V \div R_{SET}) \text{ (Amps)} \quad (3)$$

### PWM BRIGHTNESS CONTROL PROCEDURES

The brightness of the LEDs can be linearly varied from zero up to the maximum programmed current level by applying a Pulse-Width-Modulated signal to the EN pin of the LM3590. The following procedures illustrate how to program the LED drive current and adjust the output current level using a PWM signal.

1. Determine the maximum desired I<sub>OUT</sub> current. Use the I<sub>OUT</sub> equation to calculate R<sub>SET</sub>
2. Brightness control can be implemented by pulsing a signal at the EN pin. LED brightness is proportional to the duty cycle (D) of the PWM signal. For linear brightness control over the full duty cycle adjustment range, the PWM frequency (f) should be limited to accommodate the turn-on time (T<sub>ON</sub> = 50μs) of the device.
 
$$D \times (1/f) > T_{ON} f_{MAX} = D_{MIN} \div T_{ON}$$
 If the PWM frequency is much less than 100Hz, flicker may be seen in the LEDs. For the LM3590, zero duty cycle will turn off the LEDs and a 50% duty cycle will result in an average I<sub>OUT</sub> being half of the programmed LED current. For example, if R<sub>SET</sub> is set to program 15mA, a 50% duty cycle will result in an average I<sub>LED</sub> of 7.5mA.

### POWER DISSIPATION

The power dissipation (P<sub>DISSIPATION</sub>) and junction temperature (T<sub>J</sub>) can be approximated with the equations below. P<sub>IN</sub> is the product of the input current and input voltage, P<sub>IOUT</sub> is the power consumed by the LEDs, T<sub>A</sub> is the ambient temperature, and θ<sub>JA</sub> is the junction-to-ambient thermal resistance for the SOT23-5 package. V<sub>IN</sub> is the input voltage to the LM3590, V<sub>IOUT</sub> is the sum of the forward voltages of LEDs connected to the I<sub>OUT</sub> pin, and I<sub>OUT</sub> is the programmed LED current.

$$P_{DISSIPATION} = P_{IN} - P_{IOUT} \quad (4)$$

$$= (V_{IN} \times I_{OUT}) - (V_{IOUT} \times I_{OUT}) \quad (5)$$

$$T_J = T_A + (P_{DISSIPATION} \times \theta_{JA}) \quad (6)$$



The junction temperature rating takes precedence over the ambient temperature rating. The LM3590 may be operated outside the ambient temperature rating, so long as the junction temperature of the device does not exceed the maximum operating rating of 110°C. The maximum ambient temperature rating must be derated in applications where high power dissipation and/or poor thermal resistance causes the junction temperature to exceed 110°C.

### Application Circuits

Figure 5 shows how to program the LED current to four different DC levels using two digital logic signals. The programmed LED current is a function of the equivalent resistance on the I<sub>SET</sub> pin (R<sub>ISET</sub>), resulting from the logic signals on SET1 and SET2. Example values for R1, R2, and RSET on the resulting 4 current levels are shown below.

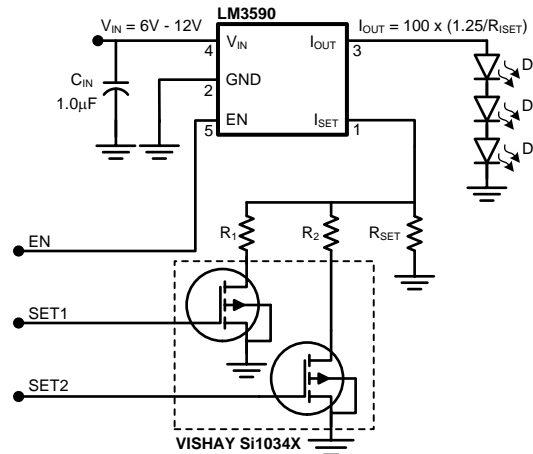

Figure 5. Example: R<sub>1</sub> = 15.8kΩ, R<sub>2</sub> = 31.6kΩ, R<sub>SET</sub> = 31.6kΩ

Table 3. Digital LED Current Programming

EN	SET1	SET2	R <sub>ISET</sub>	Example R <sub>ISET</sub>	Example I <sub>OUT</sub>
0	X	X	Shutdown	Shutdown	Shutdown
1	1	1	R <sub>SET</sub>   R <sub>1</sub>   R <sub>2</sub>	31.6kΩ  15.kΩ  31.6kΩ	16mA
1	1	0	R <sub>SET</sub>   R <sub>1</sub>	31.6kΩ  15.kΩ	12mA
1	0	1	R <sub>SET</sub>   R <sub>2</sub>	31.6kΩ  31.6kΩ	8mA
1	0	0	R <sub>SET</sub>	31.6kΩ	4mA

## IMPORTANT NOTICE

Texas Instruments Incorporated and its subsidiaries (TI) reserve the right to make corrections, enhancements, improvements and other changes to its semiconductor products and services per JESD46, latest issue, and to discontinue any product or service per JESD48, latest issue. Buyers should obtain the latest relevant information before placing orders and should verify that such information is current and complete. All semiconductor products (also referred to herein as "components") are sold subject to TI's terms and conditions of sale supplied at the time of order acknowledgment.

TI warrants performance of its components to the specifications applicable at the time of sale, in accordance with the warranty in TI's terms and conditions of sale of semiconductor products. Testing and other quality control techniques are used to the extent TI deems necessary to support this warranty. Except where mandated by applicable law, testing of all parameters of each component is not necessarily performed.

TI assumes no liability for applications assistance or the design of Buyers' products. Buyers are responsible for their products and applications using TI components. To minimize the risks associated with Buyers' products and applications, Buyers should provide adequate design and operating safeguards.

TI does not warrant or represent that any license, either express or implied, is granted under any patent right, copyright, mask work right, or other intellectual property right relating to any combination, machine, or process in which TI components or services are used. Information published by TI regarding third-party products or services does not constitute a license to use such products or services or a warranty or endorsement thereof. Use of such information may require a license from a third party under the patents or other intellectual property of the third party, or a license from TI under the patents or other intellectual property of TI.

Reproduction of significant portions of TI information in TI data books or data sheets is permissible only if reproduction is without alteration and is accompanied by all associated warranties, conditions, limitations, and notices. TI is not responsible or liable for such altered documentation. Information of third parties may be subject to additional restrictions.

Resale of TI components or services with statements different from or beyond the parameters stated by TI for that component or service voids all express and any implied warranties for the associated TI component or service and is an unfair and deceptive business practice. TI is not responsible or liable for any such statements.

Buyer acknowledges and agrees that it is solely responsible for compliance with all legal, regulatory and safety-related requirements concerning its products, and any use of TI components in its applications, notwithstanding any applications-related information or support that may be provided by TI. Buyer represents and agrees that it has all the necessary expertise to create and implement safeguards which anticipate dangerous consequences of failures, monitor failures and their consequences, lessen the likelihood of failures that might cause harm and take appropriate remedial actions. Buyer will fully indemnify TI and its representatives against any damages arising out of the use of any TI components in safety-critical applications.

In some cases, TI components may be promoted specifically to facilitate safety-related applications. With such components, TI's goal is to help enable customers to design and create their own end-product solutions that meet applicable functional safety standards and requirements. Nonetheless, such components are subject to these terms.

No TI components are authorized for use in FDA Class III (or similar life-critical medical equipment) unless authorized officers of the parties have executed a special agreement specifically governing such use.

Only those TI components which TI has specifically designated as military grade or "enhanced plastic" are designed and intended for use in military/aerospace applications or environments. Buyer acknowledges and agrees that any military or aerospace use of TI components which have **not** been so designated is solely at the Buyer's risk, and that Buyer is solely responsible for compliance with all legal and regulatory requirements in connection with such use.

TI has specifically designated certain components as meeting ISO/TS16949 requirements, mainly for automotive use. In any case of use of non-designated products, TI will not be responsible for any failure to meet ISO/TS16949.

### Products

Audio	<a href="http://www.ti.com/audio">www.ti.com/audio</a>
Amplifiers	<a href="http://amplifier.ti.com">amplifier.ti.com</a>
Data Converters	<a href="http://dataconverter.ti.com">dataconverter.ti.com</a>
DLP® Products	<a href="http://www.dlp.com">www.dlp.com</a>
DSP	<a href="http://dsp.ti.com">dsp.ti.com</a>
Clocks and Timers	<a href="http://www.ti.com/clocks">www.ti.com/clocks</a>
Interface	<a href="http://interface.ti.com">interface.ti.com</a>
Logic	<a href="http://logic.ti.com">logic.ti.com</a>
Power Mgmt	<a href="http://power.ti.com">power.ti.com</a>
Microcontrollers	<a href="http://microcontroller.ti.com">microcontroller.ti.com</a>
RFID	<a href="http://www.ti-rfid.com">www.ti-rfid.com</a>
OMAP Applications Processors	<a href="http://www.ti.com/omap">www.ti.com/omap</a>
Wireless Connectivity	<a href="http://www.ti.com/wirelessconnectivity">www.ti.com/wirelessconnectivity</a>

### Applications

Automotive and Transportation	<a href="http://www.ti.com/automotive">www.ti.com/automotive</a>
Communications and Telecom	<a href="http://www.ti.com/communications">www.ti.com/communications</a>
Computers and Peripherals	<a href="http://www.ti.com/computers">www.ti.com/computers</a>
Consumer Electronics	<a href="http://www.ti.com/consumer-apps">www.ti.com/consumer-apps</a>
Energy and Lighting	<a href="http://www.ti.com/energy">www.ti.com/energy</a>
Industrial	<a href="http://www.ti.com/industrial">www.ti.com/industrial</a>
Medical	<a href="http://www.ti.com/medical">www.ti.com/medical</a>
Security	<a href="http://www.ti.com/security">www.ti.com/security</a>
Space, Avionics and Defense	<a href="http://www.ti.com/space-avionics-defense">www.ti.com/space-avionics-defense</a>
Video and Imaging	<a href="http://www.ti.com/video">www.ti.com/video</a>

### TI E2E Community

[e2e.ti.com](http://e2e.ti.com)